

FICHA TECNICA HERRAMIENTAS ELECTRICAS

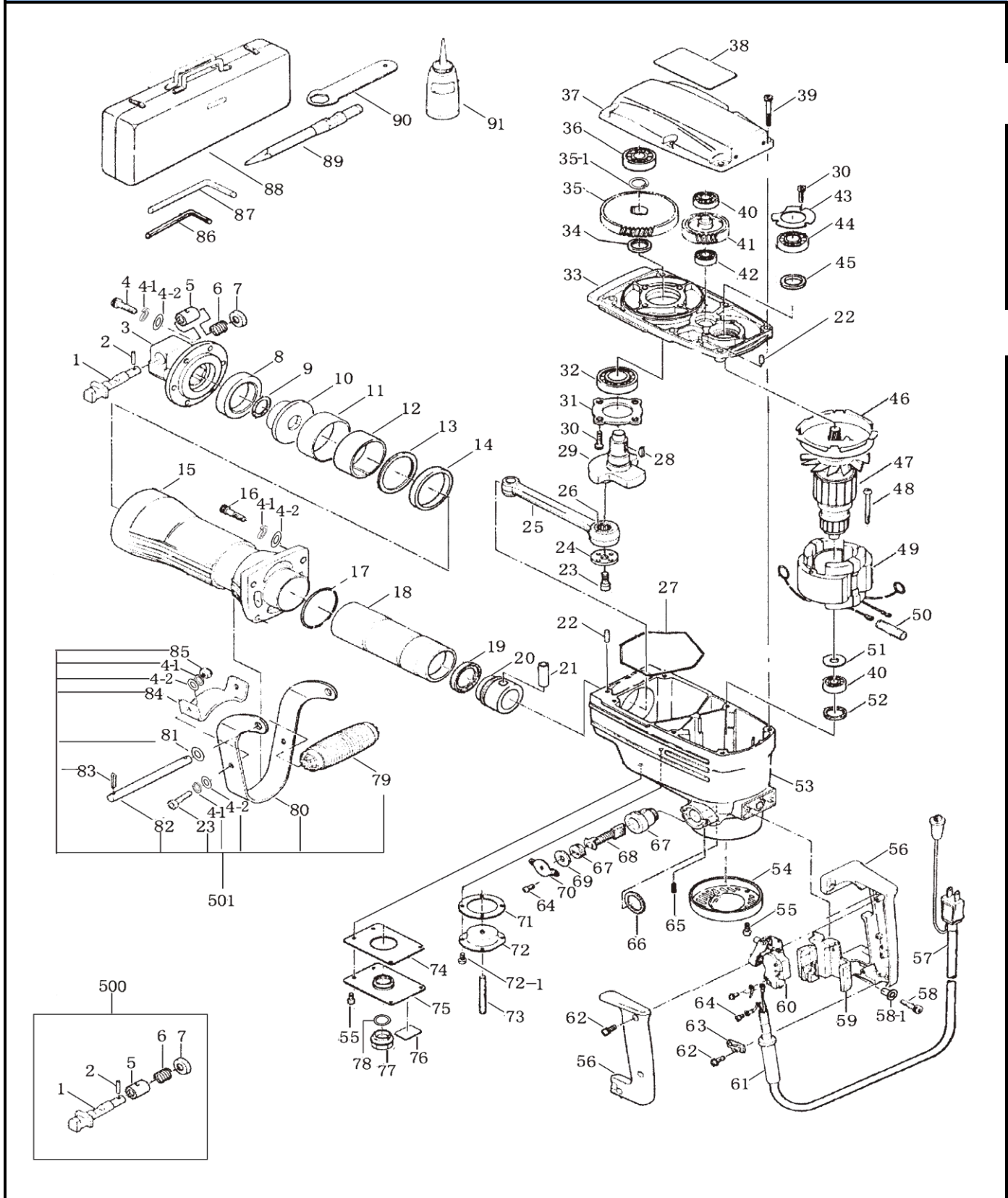







EQUIPO	CODIGO	DESCRIPCION	MODELO	
	128843	DEMOLEDOR 30mm	TKDH-30	
	ESPECIFICACIONES TECNICAS			
	POTENCIA:	1.240W	VELOCIDAD:	1.400rpm/42julios
VOLTAJE:	110V/60Hz	PESO:	15 Kg.	

DESPIECE



N°	IMAGEN	CÓDIGO DE ESK	DESCRIPCIÓN	DATOS TECNICOS	COMPATIBILIDAD
1			PALANCA DE PARADA		
2			CUÑA	3X12mm	
3			CUBIERTA FRONTAL		
4			TORNILLO	12.9	
4.1			ARANDELA DE RESORTE		
4.2			ARANDELA PLANA		
5			MANGUITO DEL RESORTE	22x28mm	
6			RESORTE	ACERO	
7			ARANDELA	12mm	
8			COJINETE	65x13mm	
9			JUNTA TORICA	3x4mm	
10			CASQUILLO DE POSICIONAMIENTO		
11			MANGUITO DE GOMA		
12			ANILLO DE RETENCION	64x27mm	
13			JUNTA TORICA	68x8mm	
14			ARANDELA PLANA	68mm	
15			CARCAZA DEL SISTEMA HIDRAULICO		
16			TORNILLO	12.6	
17			JUNTA TORICA		
18			CAMISA DEL CILINDRO	56x168mm	
19			ESTOPERA	44x6mm	
20			PISTON		
21			PASADOR DEL PISTON	11x43mm	
22			PIN	4x11mm	
23			TORNILLO	12.9	
24			ARANDELA DEL CIGÜEÑAL		

25			BIELA		
26			RODAMIENTO DE AGUJA	NKF182620	
27			JUNTA TORICA		
28			CUÑA	11x15mm	
29			CIGÜEÑAL		
30			TORNILLO	12.9	
31			TAPA DEL RODAMIENTO		
32			RODAMIENTO	6205 DU	
33			CUBIERTA MEDIA		
34			ANILLO DISTANCIADOR	33x6mm	
35		389312	ENGRANAJE		
35,1			RETEN	24mm	
36			RODAMIENTO	6302VV	
37			TAPA SUPERIOR		
38			ETIQUETA DE IDENTIFICACIONES		
39			TORNILLO	12.9	
40			RODAMIENTO	6302VV	
41		392324	ENGRANAJE		
42			RODAMIENTO	6001DU	
43			TAPA DEL COJINETE		
44			RODAMIENTO	6203VV	
45	N/A		JUNTA	N/A	
46			ANILLO GUIA		
47		389270	INDUCIDO	52x35x190mm	

48			TORNILLO		
49			CAMPO	80x93x79mm	
50	N/A		REVESTIMIENTO DE AISLAMIENTO	PLASTICO	
51			ARANDELA	11x23mm	
52			ARANDELA ONDULADA	30mm	
53			CAJA DE ENGRANAJES		
54			CUBIERTA POSTERIOR		
55			TORNILLO	12.9	
56			MANGOS DE AGARRE		
57			CABLE DE ALIMENTACION		
58			TORNILLO		
58,1			BUJE DEL TORNILLO		
59			FUNDA DEL INTERRUPTOR		
60			SWITCH	FS 072-10/02	
61			PROTECTOR DEL CABLE		
62			TORNILLO		
63			SOPORTE DEL CABLE		
64	N/A		TORNILLO	N/A	
65			TORNILLO		
66			ALMOHADILLA DE AHISLAMIENTO		
67			TAPA Y PORTA CARBON		
68			CARBON	LARGO:16mm ALTO: 16mm ANCHO: 6mm	
69			ARANDELA DE GOMA		
70			TAPA		
71			ARANDELA DE SELLADO		
72			BASTIDOR		

72,1			TORNILLO		
73					
74			EMPACADURA		
75			TAPA		
76	N/A		ETIQUETA	N/A	
77			REGLA DEL ACEITE		
78			JUNTA		
79			ASA DE AGARRE		
80			EMPUÑADURA		
81			ARANDELA		
82			TORNILLO		
83			BASE		
84			BARRA LATERAL		
85			TUERCA		
86			LLAVE		
87			LLAVE		
88			CAJA METALICA		
89			CINCEL		
90			LLAVE		
91			DEPOSITO DE ACEITE		