

FICHA TECNICA HERRAMIENTAS ELECTRICAS

EQUIPO	CODIGO	DESCRIPCION	MODELO
	309724	LIJADORA ORBITAL 90x187mm	TKOS-185





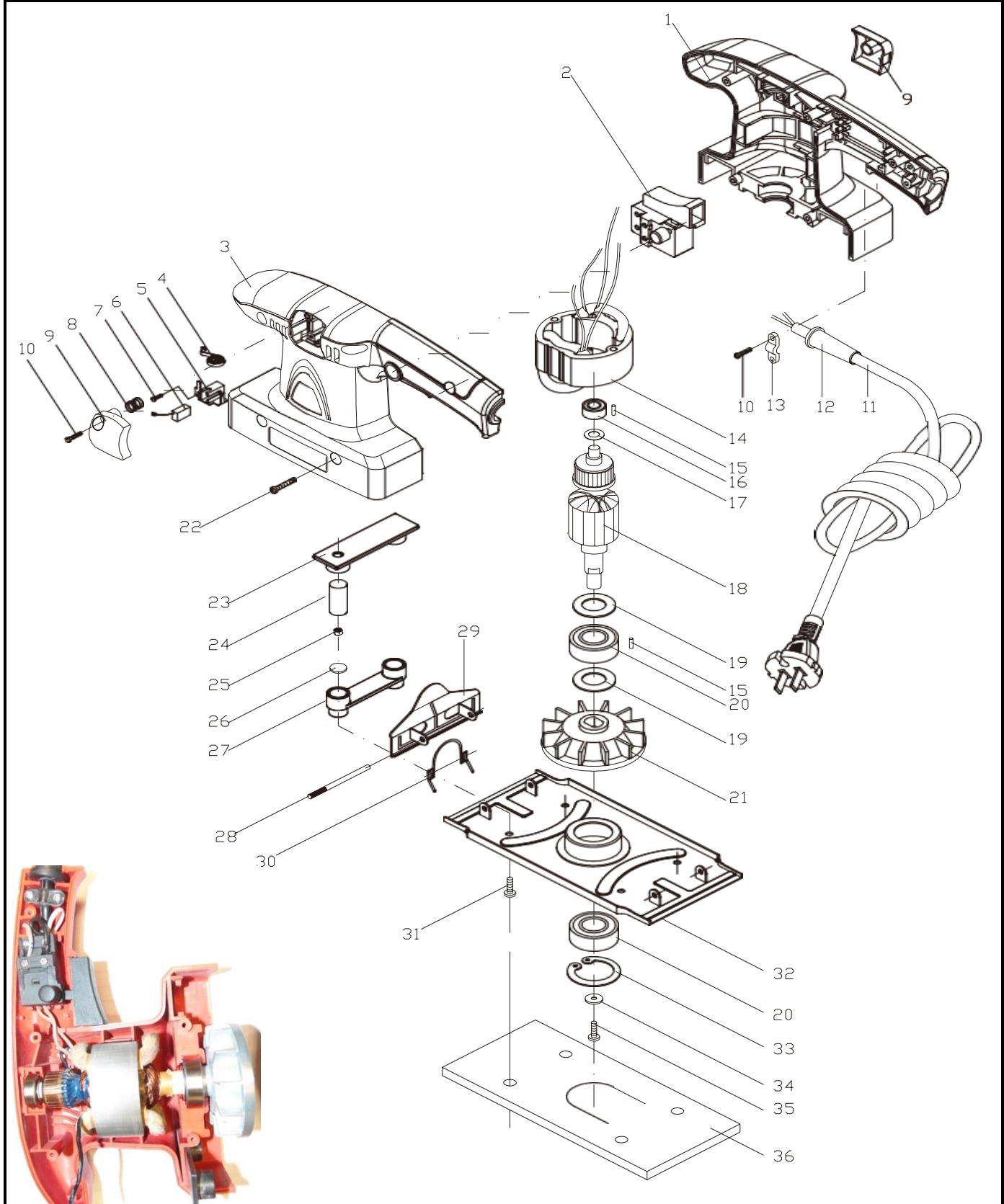

ESPECIFICACIONES TECNICAS

POTENCIA:	350W	VELOCIDAD:	13.000 rpm
VOLTAJE:	110V/60Hz	PESO:	1.8 Kg

DESPIECE



N°	IMAGEN	CÓDIGO SVK	DESCRIPCIÓN	DATOS TECNICOS	COMPATIBILIDAD
1			CARCAZA DERECHA	NYLON	
2			SWITCH DE ENCENDIDO	FA 312 FA2-6/2137	
3			CARCAZA IZQUIERDA		
4			RESORTE	ACERO	
5			PORTA CARBON	BRONCE	
6			CARBON	LARGO:16mm ALTO:7mm ANCHO:4mm	
7			TORNILLO		
8			RESORTE	ACERO	
9			TAPA DEL PORTA CARBON	PLASTICO	
10			TORNILLO		
11			CABLE DE PODER		
12			PROTECTOR DEL CABLE	GOMA	
13			SOPORTE DEL CABLE		
14			CAMPO	61x53x54mm	
15			Pin	GOMA	
16			RODAMIENTO	627ZT	
17			GUARDAPOLVO	13mm	
18			GUARDAPOLVO	19mm	
19			RODAMIENTO	6201VV	
20			VENTILADOR		
21			TORNILLO		
22			PLACA DE CONEXIÓN	PLASTICO	
23			BIELA	PLASTICO	
24			TORNILLO		

25			JUNTA DE GOMA		
26			ALMOHADILLA		
27			Pin		
28			PINZA DEL PAPEL DE LIJA		
29			RESORTE		
30			TORNILLO		
31			PLACA		
32			ARO DE RETENCION	32mm	
33			ARANDELA DE CONO	18mm	
34			TORNILLO		
35			ALMOHADILLA DE ESPUMA		
36		390641	INDUCIDO	35x22x124mm	